



**ZOHD SYSTEM LIAN**

SMART HOME



## PREFACE:

**Zian System Lian** Company was established in **1392** and in **1393** entered the field of design and production of intelligent building systems. The years 95-93 were spent on research, prototyping and pilot performances, and finally from the fall of **1995**, official sales and the first sample of ready-to-serve products were made. hardware and software updates have been done twice a year. The process of updates continues without any interruption with the aim of increasing the efficiency and optimization of products and keeps up with the latest changes in the electronic world. The company became a member of Bushehr Persian Gulf Science and Technology Park in **2015**, and in **2016**, it was approved as a new knowledge-based certification. With the increase of production and sales process for many years, it succeeded in obtaining the approval of production knowledge-based co. in **2019**.

## Index

|                                 |    |
|---------------------------------|----|
| 7-inch touch panel.....         | 2  |
| Smart touch key.....            | 3  |
| Smart relay.....                | 4  |
| Smart IR sensor.....            | 5  |
| Battery backup.....             | 6  |
| Smart RGB driver.....           | 7  |
| Code & card access control..... | 8  |
| Music player.....               | 9  |
| Ceiling speaker.....            | 10 |
| Home party.....                 | 11 |

## 7" TOUCH PANEL ZSL-P-V10

ZSL intelligent system central server and executor of all intelligent building scenarios. All equipment is connected to ZSL touch panel.

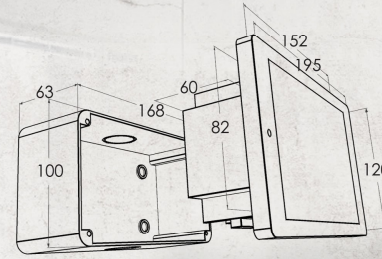





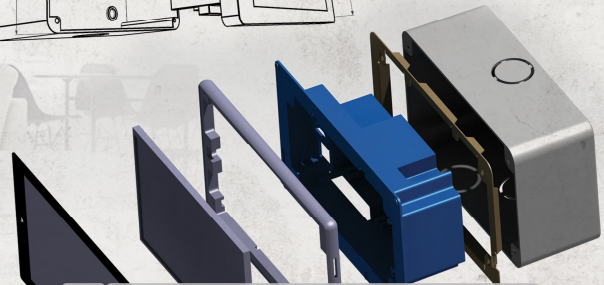

### Mechanical specification

| Size            | Dimension  |
|-----------------|------------|
| Front frame     | 195*120    |
| Back body       | 152*82     |
| Installing ring | 180*116    |
| Installing box  | 168*100*63 |

All sizes are in millimeters.



-  ARM- powerful processor by USA
-  Colored 7" display with 800\*480 pixel
-  Full glass 7" capacitive touch screen by Lenovo
-  Supported Protocols : RS433 & 484MHz
-  Time and calendar
-  Support 16GB SD card and photo screen saver
-  Network mobile connection GSM & GPRS
-  Power : 12VDC-2A
-  Aluminum frame with coloring
-  Execute smart scenarios
-  Supported android and iPhone app



## SMART TOUCH KEY: ZSL-SW(4)2-lite(pro)

The best alternative to traditional keys with a beautiful appearance and a combination of metal and glass. Installed in various electrical cans. It has background and frame colors.

### Mechanical specification

| Size            | Dimension |
|-----------------|-----------|
| Front frame     | 87*87     |
| Back body       | 54*51     |
| Installing ring | 80*73     |
| Depth           | 51        |
| Installing box  | 70*70*50  |

All sizes are in millimeters.

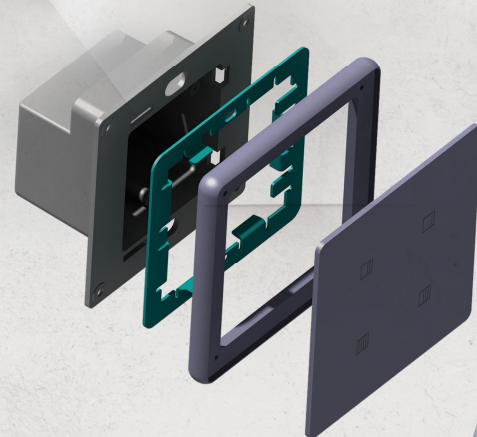
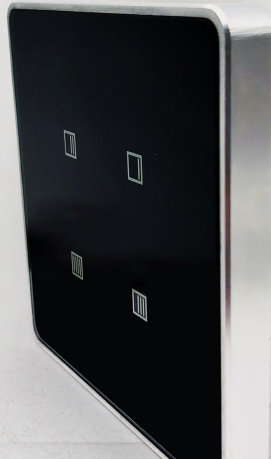
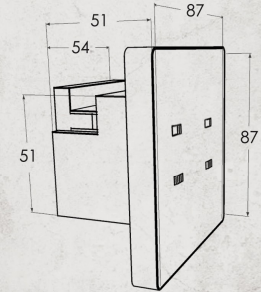

250VAC-10A contact relays



Power : 12VDC-1A



Anti-scratch glass with coloring



Aluminum frame with coloring



ARM powerful processor



Supported Protocols : RS433 & 484MHz



Four version : 4 & 2 gang – lite & pro



Coloring touch bottoms





## SMART RELAY ZSL-SW(6)3-lite(pro)









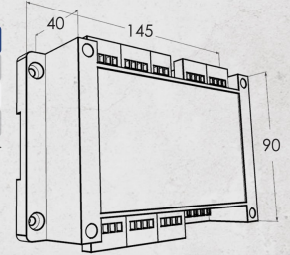





ZSL Smart Relay is a complete set of required inputs and outputs. It is connected to the control panel and installed in the electrical panel of the building

### Mechanical specification

| اندازه | اندازه |
|--------|--------|
| Length | 145    |
| Width  | 90     |
| Height | 40     |

All sizes are in millimeters.



-  250VAC-10A contact relays
-  Power : 12VDC-2A
-  Din rail installation
-  ARM powerful processor
-  Supported Protocols : RS433 & 484MHz
-  Four version : 6 & 3 gang – lite & pro
-  Push bottom for manual control
-  2 motion detection zone
-  2 gas and smoke detector zone
-  Alarm & gas cut-off & Door outputs
-  220 6VAC inputs
-  Supported android and iPhone app
-  Diagnosis of electricity
-  Display of Network and sensors condition with LEDs

## SMART IR SENSOR ZSL-IR-V1

smart infrared sensor for remote control devices. Thermostatic control of split air conditioners and control of audio and home theater players in ZSL smart system

### Mechanical specification

| Size     | Dimension |
|----------|-----------|
| Diameter | 74        |
| Height   | 25        |

All sizes are in millimeters.

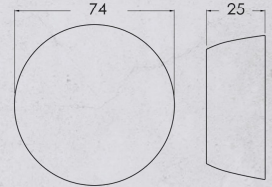

Power : 12VDC-2A



Ceiling installation



ARM powerful processor



Supported Protocols : RS433 & 484MHz



360 degree IR transmitting



Learning different AC remote



Learning different audio system remote



## BATTERY BACKUP: ZSL-DCUPS-V3

The ZSL backup battery keeps the smart system on when needed, keeping alarms, fire alarms and door controls active.



### Mechanical specification

| Size   | Dimension |
|--------|-----------|
| Length | 115       |
| Width  | 90        |
| Height | 40        |

All sizes are in millimeters.

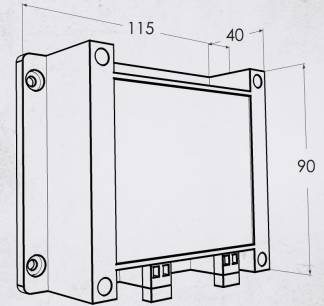

3 cell lithium battery with 2000mAh



Phoenix connection for input and output



Din rail installation



Needed charger : 12VDC-2A



Containing Battery protection



Output : 12VDC-2A

## SMART RGB DRIVER ZSL-RGB-V1

Choose RGB brightness color in a wide range of colors using ZSL smart RGB driver in smart system. Execute various scenarios including feed, flasher and rainbow and a combination of them.

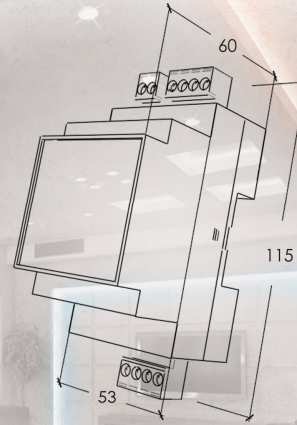

### Mechanical specification

| Size   | Dimension |
|--------|-----------|
| Length | 115       |
| width  | 53        |
| Height | 60        |

All sizes are in millimeters.



Power : 12VDC 1A



Din rail installation



Supported Protocols : RS433 & 484MHz



Output RGB power : 60W



## CODE & CARD ACCESS CONTROL

Unlock the security door, parking door, alley door or any door without the need for a traditional key, just by entering the password or holding the RFID card in front of the access control. The traditional key can be used for emergencies. Open the door to others when you are not home

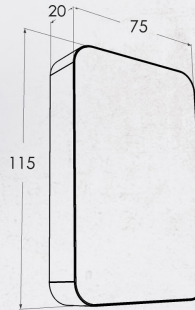

Mechanical specification

| Size  | Dimension |
|-------|-----------|
| Front | 115*75    |
| Depth | 20        |

All sizes are in millimeters.



Power : 12VDC 1A



ABS body



Touch Keypad



ID RFID receiver



Door opening key with code and tag



Doorbell key



User management with code and tag

## MUSIC PLAYER

Wall-mounted player and amplifier with semiconductor technology in sound amplification, high quality and low volume and very low power consumption. Stereo system in audio playback

### Mechanical specification

| Size            | Dimension |
|-----------------|-----------|
| Front frame     | 86*86     |
| Back body       | 62*62     |
| Installing ring | 74*72     |
| Depth           | 50        |
| Installing box  | 70*70*50  |

All sizes are in millimeters.

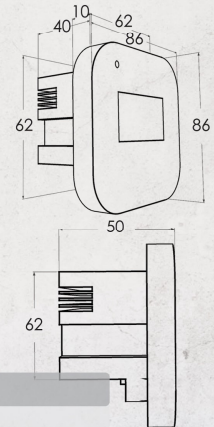

SMD 30W amplifier



Stereo music system



Inputs: Bluetooth – TV – FM radio – USB – SD card



1 to 4 ceiling speakers



2" TFT display



Different touch keys



IR remote control



Power : 220VAC



ABS body

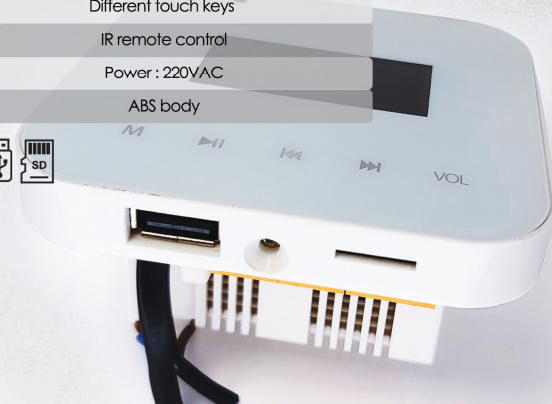



## CEILING SPEAKER

40 watt quality ceiling speaker suitable for connecting to wall and ceiling amplifiers. Long life without compromising sound quality. Use frames without frames and without using magnets

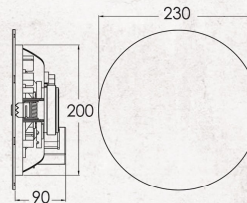

Mechanical specification

| Size  | Dimension |
|-------|-----------|
| Front | 230       |
| Back  | 90        |
| Hole  | 200       |

All sizes are in millimeters.



Frequency response 20-50KHz



Cross-over filter



Max power 40W



8 ohm resistance



Non-magnetic front frame



Combination of sub and twitter



ABS and metal body



## HOME PARTY

A 4-function lighting device suitable for use in celebrations and celebrations in a variety of residential, office and commercial buildings.

Can be installed permanently and used portable.

### Mechanical specification

| Size   | Dimension |
|--------|-----------|
| Length | 170       |
| Width  | 160       |
| Height | 80        |

All sizes are in millimeters.

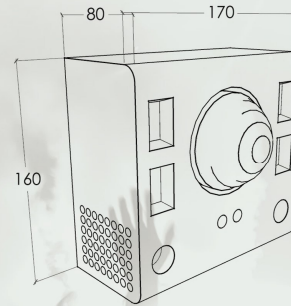

Metal black body



Power : 220-95VAC 60-50Hz 50W consumption



Magic ball 15W



Strobe 20W Frequency flashing : 20 times/sec



Purple light 12W



Red & green laser 30mW



Working mode : DMX512, master/slave, self-walking, voice control



Dimming mode : 0-100% ultra-smooth dimming



Control mode : international DMX 512, 14channel







[www.zohdiran.ir](http://www.zohdiran.ir)

Ways of communication:

Head Office and Sales Address: Unit 4 ,404th Floor, Persian Gulf Science and Technology Park, Ferdowsi St, Imam Khomeini St, Bushehr, Iran , Contact:

**09173726823** Zahedi

---

**@zsl\_lia** E-mail: **zohdsystemlian@gmail.com**

Address of Design and Production Office: 8th Alley, Taleghani St, Abuzar St, Jei St, Isfahan, Iran, Contact: **03135304051 - 09132027628** Jafari